

warmtiles[®]
add a touch of warmth



Warm Tiles™ Electric Floor Warming Systems
A complete selection of floor warming solutions.

EMERSON™

Even in warm climates, tile, stone, marble and laminate floors can feel uncomfortably cold.



Warm Tiles™ floor warming systems remove the chill with a gentle, continuous warmth. Warm Tiles™ may be installed directly over plywood, concrete or cement backerboard substrates. The warming element rests in the mortar below your floor surface. Simple to measure, quick to install and easy to control, Warm Tiles™ delivers affordable luxury.

The pictures and illustrations represented in the following pages are for illustrative purposes only, and do not necessarily represent the exact products, placement, or dimension in the context they are found in. For additional information, please refer to product specific ordering tables and installation instructions (available at easyheat.com) for more details.



Product Selection Guide

Warm Tiles™ has a complete solution for your floor warming needs. Explore our floor warming products including cable systems, ultra thin or self-adhesive mats and cable solutions for use with uncoupling membrane. ▶ [p4](#)

Warm Tiles™ Electric Floor Warming Cables (DFT)

Warm Tiles™ Electric Floor Warming Cables (DFT) are designed to supply plenty of warmth and provide ultimate freedom in warming floors regardless of the shape of your room. ▶ [p5](#)

Warm Tiles™ Floor Warming Cable for use with Uncoupling Membrane (DMC)

Warm Tiles™ Electric Floor Warming Cable for Uncoupling Membrane (DMC) is specially designed to be used with all available uncoupling membranes. ▶ [p9](#)

Warm Tiles™ Electric Self-Adhesive Mats (SAM)

Warm Tiles™ Electric Self-Adhesive Mats (SAM) are ideally suited for rectangular areas, multi-dwelling residences, or expansive rooms. ▶ [p13](#)

Warm Tiles™ Electric Floor Warming Elite Mat (WTE)

Warm Tiles™ Electric Floor Warming Elite Mats (WTE) are super thin and designed for indoor floor warming applications which require minimal impact on floor height. They also reduce installation time and labor cost due to their special pre-manufactured mat design. ▶ [p17](#)

Warm Tiles™ Thermostats

Warm Tiles™ floor warming line voltage thermostats are dual-voltage and energy-efficient to maintain the perfect floor temperature. ▶ [p22](#)

Warm Tiles™ Floor Warming Accessories

Warm Tiles™ has a wide array of accessories; relay kits, electric fault indicators, repair kits, replacement clips, strapping concrete tape and sensor wire. ▶ [p24](#)

Warm Tiles™ Floor Warming Terminology Guide

Floor warming terminology can be a bit overwhelming. Use our floor warming terminology guide to understand frequently used industry terms. ▶ [p27](#)

Warm Tiles™ Floor Warming Product Selection Guide

Criteria	DFT	DMC	SAM	WTE
1. What is the target application?				
Typical Application	Residential, Commercial	Residential, Commercial	Residential, Commercial	Residential, Commercial
2. Can it be used with uncoupling membrane?				
For use with uncoupling membrane	✓①	✓①	—	—
3. Would you prefer a cable or mat?				
Cable	✓	✓	—	—
Mat	—	—	✓	✓
4. What are the layout options?				
Layout Options	Custom, based on area, using strapping	Custom, based on area, using uncoupling membrane	Rectangular	Standard, rectangular and custom
5. What is impact will it have on my floor height?				
Impact on floor height	An additional 0.344"	An additional 0.387"	An additional 0.387"	An additional 0.211"
6. What will be your the final floor finish?				
Ceramic/Porcelain Tile	✓	✓	✓	✓
Engineered Wood ②	✓①	✓①	✓①	✓①
Terrazo	✓	✓	✓	✓
Natural Stone	✓	✓	✓	✓
Laminate floor	✓	✓	✓	✓
Luxury Vinyl Tile	✓	✓	✓	✓
Marble	✓	✓	✓	✓
7. What is the subfloor material?				
Exterior Grade Plywood	✓①	✓①	✓①	✓
Existing Ceramic Tile	✓	✓	✓	✓
Concrete/Masonry	✓	✓	✓	✓
Cement Backer Boards	✓	✓	✓	✓
Properly Prepared Vinyl	✓①	✓①	✓①	✓①
Hardwood	✓	✓	✓	✓
8. What is the time of installation?				
Time of installation	⊕⊕⊕	⊕⊕	⊕⊕	⊕
9. What is the difficulty of installation?				
Ease of Installation	Medium	Easy	Easy	Easy
10. What is the available supply voltage?				
Supply Voltage (Vac)	120, 240	120, 240	120, 240	120, 240
11. What is cold lead length?				
Standard Cold Lead Length	10 ft (3 m)	10 ft (3 m)	15 ft (4.6 m)	15 ft (4.6 m)

✓ Applicable

— Not Applicable

① Verify with your local sales representative.

② For used under engineered, floating wood floors only. Not approved for nailed-down installations.

Warm Tiles™ DFT Cables

Floor Warming Cables. For Residential and Commercial Applications.

Product Overview

- Warm Tiles Floor Warming Cables (DFT) provide for a custom layout, based solely on walkable area.
- Plastic strapping with two different spacing options allow for the design of oversized heat output for concrete slab floors.

Applications

- DFT cables are designed to gently and evenly warm flooring materials such as:
 - Ceramic, porcelain or glass tile
 - Marble, granite or slate
 - Laminate hardwoods
 - LVT (Luxury Vinyl Tile)
 - Stone (poured or dimensional)

Features

- Available in 120 and 240 Vac kits.
- Easily installed on subfloor or concrete slab, in thin-set or self-leveling compound materials.
- Supplied with standard 10 ft (3.05 m) cold leads, DFT cables are designed to supply at least 12 W/ft² – 15 W/ft² when installed per instructions.
- Low profile cable thickness with minimal increase in floor height.
- Included plastic strapping strips secure the DFT cable and plastic clips secure the floor temperature probe.
- Designed with different cable spacing options for more optimal heating performance to accommodate varying heat loss in different installation environments.
- DFT Cable Strapping is constructed of an all plastic material which does not tear, cut or harm the cable in any way during installation and can help to protect the cable from damage when walked on or from objects dropped onto it.
 - Strips come in one foot increments, with mating tabs to connect multiple strips together for an unlimited length run.
 - Strapping lays perfectly flat, keeping the cables low to the surface and minimizing any height increases to the floor.
 - Our rounded channel design allows the cable to glide smoothly when tensioning and will not bend or cause pinch points.
- Can also be installed within an uncoupling membrane. *Contact your local sales representative for details.*
- Fifteen year limited warranty.

Accessories

- It is recommended that a floor temperature sensing thermostat be used to control the cable system. *See Warm Tiles Thermostats.*
- Relays can be used in conjunction with a thermostat to control large heated areas where the power requirement exceeds 15 Amps. We offer relay kits for use with thermostats. *See Warm Tiles Floor Warming Accessories.*

Certifications

- UL Listed, CSA Certified and conform to European Directives.

Included in Box

- DFT cable, plastic strapping, floor temperature probe with 15 ft (3 m) lead, probe/cable clips, tri-language Installation Instructions.



Notes

- Per NEC and CEC requirements **ALWAYS** use a ground fault protection device (GFCI) to reduce the danger of fire from a damaged or improperly installed heating cable. Electrical fault currents caused by damaged or improperly installed cable **MAY NOT BE LARGE ENOUGH** to trip a conventional circuit breaker.
- Heating cables must be installed in compliance with all national, state/provincial and local codes. Check with your local electrical inspector for specific details.
- The Warm Tiles heating cables must be completely embedded in a cement-based layer of mortar prior to installation of the flooring material. DFT cable with strapping will add approximately 0.21 in (6 mm) to the floor height. If cables are exposed, they could be damaged which would expose live electrical parts and/or cause the cable to overheat.
- Cables are designed as a supplementary heat source and not as a primary source of space heating for any room in which it is installed.
- Floor areas may be warmed with a single cable or by using a combination of cables, provided the area to be heated is equal to the sum of the coverage area of the individual cables.
- Heating cable must not touch, cross or overlap itself at any point and cable must not be closer than 1-1/2 in (38 mm) to adjacent cable.
- **DO NOT** install heating cable under any type of nailed-down or stapled flooring. Floor nails and staples can damage the cable resulting in exposed live electrical parts and/or result in the cable overheating.
- **DO NOT** bend the heating cable at right angles – this could damage the electrical insulation; minimum bending radius is 3/4 in (19 mm).
- **DO NOT CUT THE HEATING CABLE.** Only the cold lead may be cut to suit hook-up in the electrical connection box (ECB).

Warm Tiles™ DFT Cable

Floor Warming Cables. For Residential and Commercial Applications.

Measuring Walkable Area

Warm Tiles Warming Cables (DFT) provide unlimited design configurations for even the most difficult shaped room. The Warm Tiles cable allows you to install full floor warming coverage by lacing the cable on the floor wherever you require a heated area. Find each floor section's square area by multiplying the length and width of each walkable floor section. Then add each floor section's walkable square area together for the installation's total walkable square area.

DFT Cable Kit Room Measurement Diagram

Shaded areas represent installation area of your DFT cable system.

A is 2 ft 6 in x 3 ft = 7.5 ft² (0.76 m x 0.91 m = 0.69 m²)

B is 2 ft 6 in x 2 ft ÷ 2 = 2.5 ft² [(0.76 m x 0.61 m) ÷ 2 = 0.23 m²]

C is 3 ft x 5 ft = 15 ft² (0.91 m x 1.52 m = 1.39 m²)

A + B + C = ft² (m²) total walkable heated area

7.5 ft² + 2.5 ft² + 15 ft² = 25 ft²

(0.69 m² + 0.23 m² + 1.39 m² = 2.31 m²) total heated area

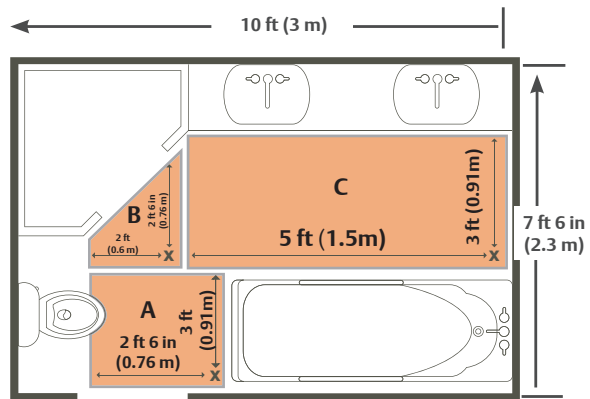

DFT Cable Kit Room Layout Diagram

Choose the product that most closely matches your heated area square footage from the product selection for Warm Tiles Cable Kits.

In this example, you would choose 120 Vac DFT 1022 cable kit for standard spacing or DFT 1030 for alternate spacing.

For additional layouts or help in choosing the right product for your project, contact your local sales representative.

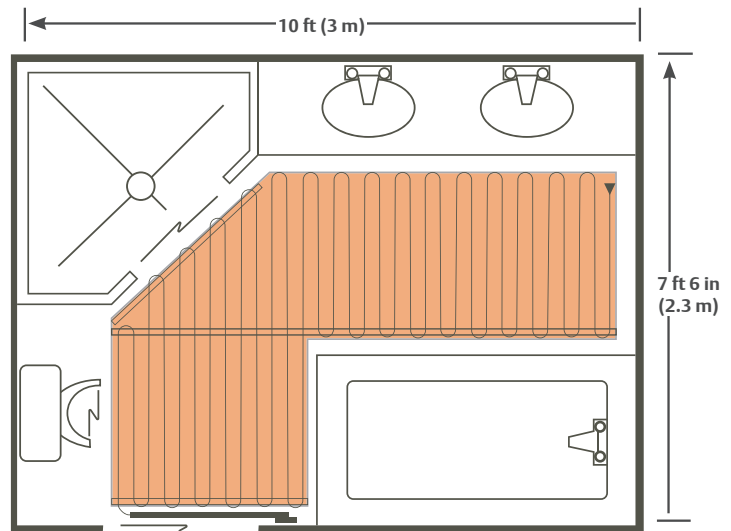

Warm Tiles™ DFT Cable

Floor Warming Cables. For Residential and Commercial Applications.

Considerations For Choosing a Cable

Floor areas may be warmed with a single cable or by using a combination of cables, provided the area to be heated is equal to the sum of the coverage area of the individual cables. Cables are normally installed using a 3 in (76.2 mm) spacing between cable runs (Standard Heating Cable Spacing). For rooms located above unheated areas, including concrete slabs on grade, the recommended spacing is 3 in – 2 in – 3 in – 2 in (75 mm -50 mm -75 mm -50 mm), etc., between cable runs (Alternating Heating Cable Spacing). The same spacing should be used over the entire installation, as non-uniform spacing will result in areas that are either significantly cooler or warmer than other areas. It is recommended to carefully measure the actual floor area to be heated (Heated Area) and use the product selection chart to verify that each cable is the correct size and voltage. Select 120 Vac or 240 Vac to match your power supply.

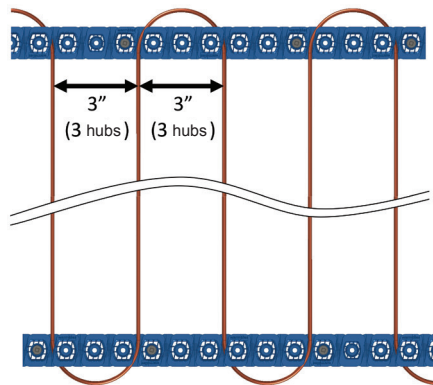

Standard Cable Spacing
3 in (75 mm)
spacing between cable runs

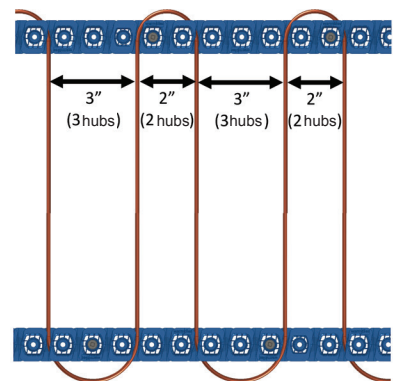

Alternating Cable Spacing
3 in – 2 in – 3 in – 2 in (75 mm -50 mm -75 mm -50 mm)
spacing between cable runs

DFT 120 Vac Cable Kits

Model	Heated Area ft ² (m ²)		Amps ①
	Standard	Alternating	
DFT 1011	10 - 13 (0.9 - 1.2)	8 - 10 (0.7 - 0.9)	1.1
DFT 1016	14 - 18 (1.3 - 1.7)	11 - 14 (1.0 - 1.3)	1.6
DFT 1022	19 - 26 (1.8 - 2.4)	15 - 22 (1.4 - 2.0)	2.2
DFT 1030	27 - 34 (2.5 - 3.2)	23 - 28 (2.2 - 2.6)	3.0
DFT 1039	35 - 42 (3.3 - 3.9)	29 - 35 (2.7 - 3.3)	4.0
DFT 1048	43 - 54 (4.0 - 5.0)	36 - 45 (3.3 - 4.2)	5.1
DFT 1059	55 - 65 (5.1 - 6.0)	46 - 54 (4.3 - 5.0)	6.4
DFT 1069	66 - 72 (6.1 - 6.7)	55 - 60 (5.1 - 5.6)	7.4
DFT 1079	73 - 82 (6.8 - 7.6)	61 - 68 (5.7 - 6.3)	8.5
DFT 1088	83 - 92 (7.7 - 8.5)	69 - 76 (6.4 - 7.1)	8.8
DFT 1098	93 - 102 (8.6 - 9.5)	77 - 84 (7.2 - 7.8)	9.6
DFT 1108	103 - 113 (9.6 - 10.5)	85 - 95 (7.9 - 8.8)	10.7

DFT 240 Vac Cable Kits

Model	Heated Area ft ² (m ²)		Amps ①
	Standard	Alternating	
DFT 2021	18 - 25 (1.7 - 2.3)	15 - 21 (1.4 - 1.9)	1.1
DFT 2031	26 - 35 (2.4 - 3.3)	22 - 29 (2.0 - 2.7)	1.6
DFT 2053	48 - 55 (4.5 - 5.1)	40 - 46 (3.7 - 4.3)	2.6
DFT 2065	60 - 70 (5.6 - 6.5)	50 - 58 (4.6 - 5.4)	3.3
DFT 2078	71 - 83 (6.6 - 7.7)	59 - 70 (5.5 - 6.5)	4.0
DFT 2095	90 - 100 (8.4 - 9.3)	75 - 84 (6.9 - 7.8)	5.1
DFT 2118	110 - 130 (10.2 - 12.1)	91 - 108 (8.5 - 10.0)	6.3
DFT 2137	131 - 145 (12.2 - 13.5)	109 - 120 (10.1 - 11.1)	7.4
DFT 2157	146 - 165 (13.6 - 15.3)	121 - 137 (11.2 - 12.7)	8.5
DFT 2175	166 - 184 (15.4 - 17.1)	138 - 153 (12.8 - 14.2)	8.8
DFT 2195	185 - 204 (17.2 - 19.0)	154 - 169 (14.3 - 15.7)	9.6
DFT 2215	205 - 225 (19.1 - 20.9)	170 - 187 (15.8 - 17.4)	10.7

① Caution: Kit combinations that exceed 10 Amps should be connected by a qualified electrician.

Warm Tiles™ DFT Cable

Floor Warming Cables. For Residential and Commercial Applications.

Product Selection

120 Vac						
Catalog Number	Description	Heated Area ft ² (m ²)		# of Strips Included	Shipping Weight lb (kg)	UPC
		Standard ①	Alternating ②			
DFT1011	"Blue" cable kit	10 - 13 (0.9 - 1.2)	8 - 10 (0.7 - 0.9)	9	4 (2)	01362701611
DFT1016	"Red" cable kit	14 - 18 (1.3 - 1.7)	11 - 14 (1.0 - 1.3)	12	4 (2)	01362701612
DFT1022	"Green" cable kit	19 - 26 (1.8 - 2.4)	15 - 22 (1.4 - 2.0)	18	4.5 (2)	01362701613
DFT1030	"Yellow" cable kit	27 - 34 (2.5 - 3.2)	23 - 28 (2.2 - 2.6)	23	9.5 (4.3)	01362701614
DFT1039	"Purple" cable kit	35 - 42 (3.3 - 3.9)	29 - 35 (2.7 - 3.3)	23	5 (3)	01362701615
DFT1048	"Orange" cable kit	43 - 54 (4.0 - 5.0)	36 - 45 (3.3 - 4.2)	41	6 (3)	01362701616
DFT1059	"Brown" cable kit	55 - 65 (5.1 - 6.0)	46 - 54 (4.3 - 5.0)	41	7 (3)	01362701617
DFT1069	"Sage" cable kit	66 - 72 (6.1 - 6.7)	55 - 60 (5.1 - 5.6)	44	7 (3)	01362701618
DFT1079	"White" cable kit	73 - 82 (6.8 - 7.6)	61 - 68 (5.7 - 6.3)	50	7 (3.2)	01362701619
DFT1088	"Pink" cable kit	83 - 92 (7.7 - 8.5)	69 - 76 (6.4 - 7.1)	50	7.5 (3.4)	01362701609
DFT1098	"Silver" cable kit	93 - 102 (8.6 - 9.5)	77 - 84 (7.2 - 7.8)	59	8 (3.6)	01362701608
DFT1108	"Black" cable kit	103 - 113 (9.6 - 10.5)	85 - 95 (7.9 - 8.8)	65	8.5 (3.9)	01362701607

240 Vac						
Catalog Number	Description	Heated Area ft ² (m ²)		# of Strips Included	Shipping Weight lb (kg)	UPC
		Standard ①	Alternating ②			
DFT2021	"A" cable kit	18 - 25 (1.7 - 2.3)	15 - 21 (1.4 - 1.9)	17	8 (3.6)	01362701621
DFT2031	"B" cable kit	26 - 35 (2.4 - 3.3)	22 - 29 (2.0 - 2.7)	24	10 (4.5)	01362701622
DFT2053	"C" cable kit	48 - 55 (4.5 - 5.1)	40 - 46 (3.7 - 4.3)	42	12 (5.4)	01362701623
DFT2065	"D" cable kit	60 - 70 (5.6 - 6.5)	50 - 58 (4.6 - 5.4)	50	15.4 (7)	01362701624
DFT2078	"E" cable kit	71 - 83 (6.6 - 7.7)	59 - 70 (5.5 - 6.5)	50	16.2 (7.4)	01362701625
DFT2095	"F" cable kit	90 - 100 (8.4 - 9.3)	75 - 84 (6.9 - 7.8)	75	18.7 (8.5)	01362701626
DFT2118	"G" cable kit	110 - 130 (10.2 - 12.1)	91 - 108 (8.5 - 10.0)	75	21.2 (9.6)	01362701627
DFT2137	"H" cable kit	131 - 145 (12.2 - 13.5)	109 - 120 (10.1 - 11.1)	75	22 (10)	01362701628
DFT2157	"I" cable kit	146 - 165 (13.6 - 15.3)	121 - 137 (11.2 - 12.7)	100	12 (5.4)	01362701629
DFT2175	"J" cable kit	166 - 184 (15.4 - 17.1)	138 - 153 (12.8 - 14.2)	100	12.7 (5.7)	01362701630
DFT2195	"K" cable kit	185 - 204 (17.2 - 19.0)	154 - 169 (14.3 - 15.7)	125	13.8 (6.3)	01362701631
DFT2215	"L" cable kit	205 - 225 (19.1 - 20.9)	170 - 187 (15.8 - 17.4)	125	15.1 (6.8)	01362701632

DFT Strapping Kit Product Selection

Catalog Number	Description	Dimensions in (mm)	Package Quantity	Weight lb (kg)	UPC
DFTS	One foot plastic strapping strips with built-in mating inter-connecting male/female connectors	5" x 15" (125 mm x 375 mm)	10	0.9 (0.4)	013627001370

All DFT cable kits include enough strapping to secure cable for square or rectangular rooms without center runs. *For hallways and non-standard sized rooms, additional strapping strips may be needed (sold separately).*

The DFTS Plastic strapping strip kit gives an installer the additional strapping strips needed for long narrow hallways and non-standard room configurations. These include areas such as:

- Long, narrow hallways
- Irregularly shaped rooms
- Areas with curves, angles, or around the-corner bends
- Kitchens with an island
- Basements with large supporting posts/columns

① Use standard spacing on floors that are located above heated areas.

② Use alternating spacing on concrete slab floors or in rooms with excessive heat loss such as solariums.

Warm Tiles™ DMC Series

Floor Warming Cable for use with Uncoupling Membrane. For Residential and Commercial Applications.

Product Overview

- Warm Tiles Electric Floor Warming Cable for Uncoupling Membrane (DMC) is the easy-to-install, reliable solution for your floor warming project.
- The cable was specially designed to be used with all available uncoupling membranes, so installation could not be simpler.

Applications

- DMC cables are designed to gently warm flooring materials such as:
 - Marble
 - Ceramic
 - Glass and porcelain tile
 - Slate
 - Granite
 - Poured or dimensional stone
 - Laminate and certain engineered hardwood products

Features

- Available in 120 and 240 Vac.
- Designed to work with 1.2" (30.5 mm) hub spacing membranes or DMCS strapping strips.
- Heating area range from 7 ft² – 250 ft² (0.7 m² – 23 m²).
- Cable can be laid directly from the spool into the membrane in the optimal spacing configuration for your installation.
- Once the cable is installed, tile installation is easy: self-leveling or scratch coat may not be required.
- Approved for a variety of applications and floor finishes for the ultimate in versatility and compatibility.
- Cables can also be installed in steps, including risers, leading to a bath/shower area in most jurisdictions. *Check with your local electrical inspector before installing in steps.*
- Fifteen year limited warranty.

Accessories

- Our Warm Tiles DMCS Cable Strapping Strips are designed to work exclusively with DMC floor-warming cables. See *Warm Tiles DMCS Cable Strapping Strips*.
- It is recommended that a floor temperature sensing thermostat be used to control the cable system. See *Warm Tiles Thermostats*.
- Relays can be used in conjunction with a thermostat to control large heated areas where the power requirement exceeds 15 Amps. We offer relay kits for use with thermostats. See *Warm Tiles Floor Warming Accessories*.

Certifications

- CSA Certified for use in both the U.S. and Canada.

Included in Box

- DMC cable, Tri-Language Instructions.

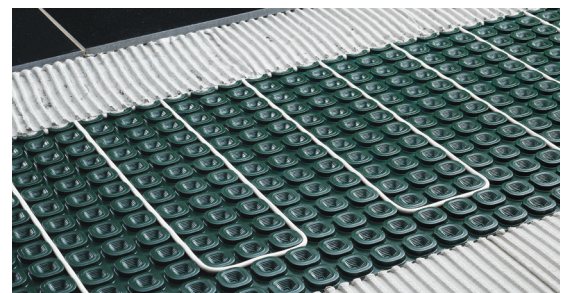

Notes

- Per NEC and CEC requirements **ALWAYS** use a ground fault protection device (GFCI) to reduce the danger of fire from a damaged or improperly installed heating cable. Electrical fault currents caused by damaged or improperly installed cable **MAY NOT BE LARGE ENOUGH** to trip a conventional circuit breaker.
- Heating cables must be installed in compliance with all national, state/provincial and local codes. Check with your local electrical inspector for specific details.
- The Warm Tiles heating cables must be completely embedded in a cement-based layer of mortar prior to installation of the flooring material. DMC cable with uncoupling membrane will add approximately 0.387 in (9.83 mm) to the floor height.
- Cables are not designed as a primary source of space heating for any room in which it is installed.
- Heating cable must not touch, cross or overlap itself at any point.
- **DO NOT** install heating cable under any type of nailed-down or stapled flooring. Floor nails and staples can damage the cable resulting in exposed live electrical parts and/or result in the cable overheating.
- Warm Tiles cables may not be installed under natural wood floors because the heat from the cables will cause these floors to warp, crack and/or discolor. Before beginning installation, check with the flooring manufacturer to verify that their materials are suitable for electric radiant underfloor heating.
- **DO NOT** bend the heating cable at right angles – this could damage the electrical insulation; minimum bending radius is 3/4 in (19 mm).
- **DO NOT CUT THE CABLE.** Only the cold lead may be cut to suit hook-up in the electrical connection box (ECB).

Warm Tiles™ DMC Cable

Floor Warming Cable for use with Uncoupling Membrane. For Residential and Commercial Applications.

Measuring Walkable Area

Warm Tiles Electric Floor Warming Cable for Uncoupling Membrane (DMC) is designed to be used with all available uncoupling membranes and can be laid directly from the spool into the membrane in whatever configuration you need. DMC allows you to install full floor warming coverage wherever you require a heated area. Find each floor section's square area by multiplying the length and width of each walkable floor section. Then add each floor section's walkable square area together for the installation's total walkable square area.

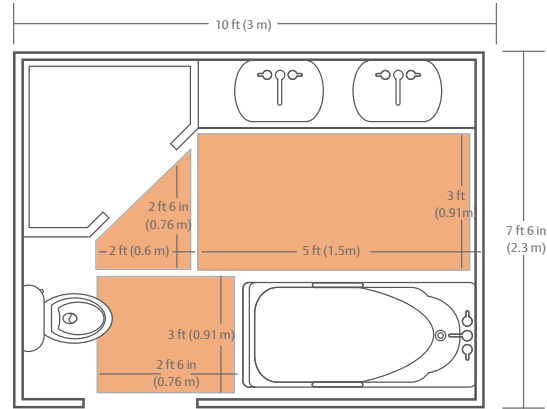

Cable Spacing

Floor areas may be warmed with a single cable or by using a combination of cables, provided the area to be heated is equal to the sum of the coverage area of the individual cables. Use standard cable spacing for rooms above heated areas. Dense cable spacing can be used for rooms above unheated areas, concrete slabs or high heat loss areas. Alternating cable spacing is used for excess cable or compensating for cable shortage. The same spacing should be used over the entire installation, as non-uniform spacing will result in areas that are either significantly cooler or warmer than other areas.

DMC Cable Spacing with Uncoupling Membrane

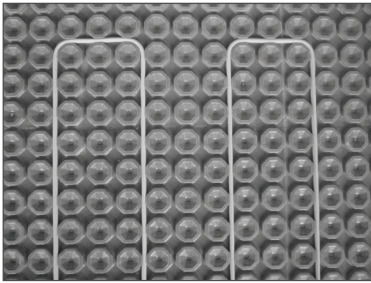

Standard Cable Spacing

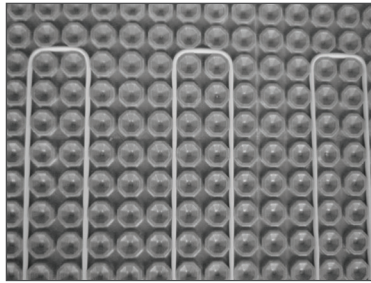

Alternating Cable Spacing

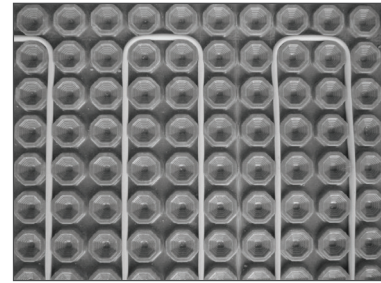

Dense Cable Spacing

DMC Cable Spacing with DMCS Strapping Strips

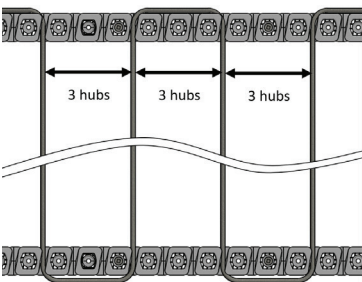

Standard Cable Spacing

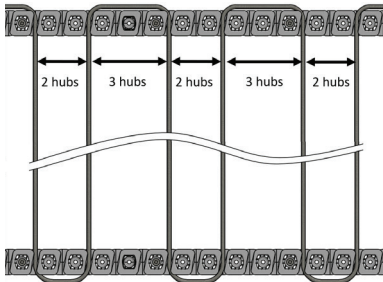

Alternating Cable Spacing

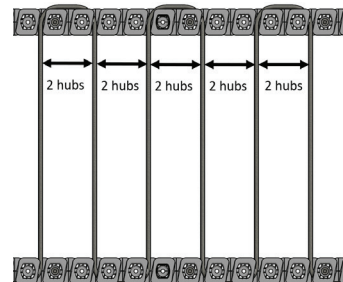

Dense Cable Spacing

Cables are spaced 3 channels/hubs apart. This results in spacing of 3-3/4 in (90 mm) between cables and provides 12 W/ft².

Cables are spaced alternately 3 channels/hubs apart and 2 channels/hubs apart. This results in spacing of 3-3/4 in (90 mm) and 2-1/2 in (60 mm) between cables and provides 15 W/ft².

Cables are spaced 2 channels/hubs apart. This results in spacing of 2-1/2 in (60 mm) between cables and provides 18 W/ft².

Warm Tiles™ DMC Cable

Floor Warming Cable for use with Uncoupling Membrane. For Residential and Commercial Applications.

Cable Length and Power Supply

It is recommended to carefully measure the actual floor area to be heated (Heated Area) and use the product selection chart to verify that each cable is the correct size and voltage. Select 120 Vac or 240 Vac to match your power supply. 240 Vac is generally more economical for areas larger than 70 ft² (6.50 m²). The following heating area tables are based on membranes with 1.25 in (32 mm) spacing. For membranes with other spacing, contact your local sales representative for more information.

DMC 120 Vac Cable Kits

Model Number	Heating Area ft ² (m ²)			Cable Length ft (m)	Current Amps
	Standard Spacing (cables are spaced 3 channels apart) ①	Alternative Spacing (cables are spaced 2 channels apart and 3 channels apart) ②	Dense Spacing (cables are spaced 2 channels apart) ③		
DMC 1012	13-15 (1.2-1.4)	11-12 (1.0-1.2)	8-10 (0.8-0.9)	44 (13)	1.3
DMC 1016	16-20 (1.5-1.9)	13-17 (1.2-1.6)	11-14 (1.0-1.3)	58 (18)	1.7
DMC 1021	22-25 (2.0-2.4)	18-21 (1.7-2.0)	15-17 (1.4-1.6)	76 (23)	2.3
DMC 1025	25-30 (2.3-2.7)	21-25 (1.9-2.3)	17-20 (1.6-1.8)	88 (27)	2.6
DMC 1031	31-37 (2.9-3.5)	26-31 (2.4-2.9)	21-25 (1.9-2.3)	109 (33)	3.3
DMC 1042	39-52 (3.6-4.8)	33-43 (3.0-4.0)	26-34 (2.4-3.2)	145 (44)	4.4
DMC 1053	53-63 (4.9-5.8)	44-52 (4.1-4.9)	35-42 (3.3-3.9)	185 (56)	5.5
DMC 1065	63-77 (5.8-7.1)	52-64 (4.9-5.9)	42-51 (3.9-4.8)	224 (68)	6.7
DMC 1081	80-94 (7.4-8.7)	66-78 (6.2-7.3)	53-63 (4.9-5.8)	277 (85)	8.3
DMC 1097	96-112 (8.9-10.4)	80-94 (7.4-8.7)	64-75 (5.9-7.0)	333 (102)	10.0
DMC 1114	111-134 (10.3-12.5)	92-112 (8.6-10.4)	74-90 (6.9-8.3)	392 (120)	11.8

DMC 240 Vac Cable Kits

Model Number	Heating Area ft ² (m ²)			Cable Length ft (m)	Current Amps
	Standard Spacing (cables are spaced 3 channels apart) ①	Alternative Spacing (cables are spaced 2 channels apart and 3 channels apart) ②	Dense Spacing (cables are spaced 2 channels apart) ③		
DMC 2021	22-25 (2.0-2.3)	18-21 (1.7-1.9)	14-17 (1.3-1.5)	75 (23)	1.1
DMC 2025	25-30 (2.4-2.8)	21-25 (2.0-2.3)	17-20 (1.6-1.8)	88 (27)	1.3
DMC 2031	31-37 (2.9-3.5)	26-31 (2.4-2.9)	21-25 (1.9-2.3)	109 (33)	1.6
DMC 2042	39-52 (3.6-4.8)	33-43 (3.0-4.0)	26-34 (2.4-3.2)	145 (44)	2.2
DMC 2054	54-64 (5.0-6.0)	45-53 (4.2-5.0)	36-43 (3.3-4.0)	189 (58)	2.8
DMC 2063	62-75 (5.7-7.0)	52-62 (4.8-5.8)	41-50 (3.8-4.6)	219 (67)	3.3
DMC 2081	79-97 (7.3-9.0)	65-80 (6.1-7.5)	52-64 (4.9-6.0)	280 (85)	4.2
DMC 2097	94-114 (8.7-10.6)	78-95 (7.3-8.9)	63-76 (5.8-7.1)	333 (102)	5.0
DMC 2113	112-130 (10.4-12.1)	94-109 (8.7-10.1)	75-87 (7.0-8.1)	389 (118)	5.8
DMC 2131	130-150 (12.1-13.9)	108-125 (10.1-11.6)	87-100 (8.0-9.3)	447 (136)	6.7
DMC 2163	157-190 (14.5-17.7)	131-158 (12.1-14.7)	104-127 (9.7-11.8)	555 (169)	8.3
DMC 2196	190-227 (17.7-21.1)	158-189 (14.7-17.5)	127-151 (11.8-14.0)	667 (203)	10.0
DMC 2231	225-265 (20.9-24.6)	187-221 (17.4-20.5)	150-177 (13.9-16.4)	785 (239)	11.8

① Standard for 12 W/ft².

② Alternate for 15 W/ft².

③ Dense for 18 W/ft².

Warm Tiles™ DMC Cable

Floor Warming Cable for use with Uncoupling Membrane. For Residential and Commercial Applications.

Product Selection

120 Vac					
Catalog Number	Cable Length ft (m)	Power Consumption (Watts)	Carton Quantity	Carton Weight lb (kg)	UPC
DMC1012	44 (13)	159	2	2.1 (1.0)	01362718810
DMC1016	58 (18)	208	2	2.7 (1.2)	01362718811
DMC1021	76 (23)	274	2	3.1 (1.4)	01362718812
DMC1025	88 (27)	315	2	3.4 (1.5)	01362718813
DMC1031	109 (33)	394	2	3.6 (1.6)	01362718814
DMC1042	145 (44)	522	2	4.0 (1.8)	01362718815
DMC1053	185 (56)	665	2	4.6 (2.1)	01362718816
DMC1065	224 (68)	805	2	5.6 (2.5)	01362718817
DMC1081	277 (85)	998	2	7.2 (3.2)	01362718818
DMC1097	333 (102)	1200	2	8.7 (3.9)	01362718819
DMC1114	392 (120)	1412	2	10.3 (4.6)	01362718820

240 Vac					
Catalog Number	Cable Length ft (m)	Power Consumption (Watts)	Carton Quantity	Carton Weight lb (kg)	UPC
DMC2021	75 (23)	268	2	2.5 (1.1)	01362718821
DMC2025	88 (27)	317	2	3.0 (1.4)	01362718822
DMC2031	109(33)	393	2	3.6 (1.6)	01362718823
DMC2042	145 (44)	522	2	4.7 (2.1)	01362718824
DMC2054	189 (58)	679	2	6.2 (2.8)	01362718825
DMC2063	219 (67)	788	2	7.1 (3.2)	01362718826
DMC2081	280 (85)	1008	2	9.1 (4.1)	01362718827
DMC2097	333 (102)	1200	2	10.9 (4.9)	01362718828
DMC2113	389 (118)	1399	2	12.7 (5.7)	01362718829
DMC2131	447 (136)	1610	2	14.6 (6.6)	01362718830
DMC2163	555 (169)	1997	2	15.5 (7.0)	01362718831
DMC2196	667 (203)	2400	2	16.3 (7.3)	01362718832
DMC2231	785 (239)	2824	2	19.0 (8.6)	01362718833

Warm Tiles™ SAM Mat

Floor Warming Self-Adhesive Mat. For Commercial and Residential Applications.

Product Overview

- Warm Tiles™ Self-Adhesive Mats (SAM) are ideally suited for rectangular areas, multi-unit applications, or expansive rooms.
- The cable is fixed onto a mesh substrate and comes in standard sizes of pre-fabricated rectangular mats with self-adhesive, wide-spaced backing to help reduce installation time and labor.

Applications

- SAM mats are designed to gently warm flooring materials such as:
 - Marble
 - Ceramic
 - Glass and porcelain tile
 - Slate
 - Granite
 - Poured or dimensional stone
 - Laminate and engineered hardwood products

Features

- Available in 120 and 240 Vac with standard 15 ft (4.6 m) cold leads.
- Ideal for large areas, just roll out and affix to the subfloor.
- Mats can be altered in the field to fit various floor layouts.
- Comes in standard 20 in (0.51 m) rolls that are easy to stock and carry to the jobsite.
- Provides 15 W/ft², 14 W/ft² for select models, to quickly and efficiently warm floors.
- Plastic mesh substrate (not cable) can be cut to allow for additional layout customization.
- Custom mats are available for various shaped areas that do not conform to standard mat kits, such as ovals, circles and triangles. Contact your local representative for details.
- Approved for a variety of applications and floor finishes for the ultimate in versatility and compatibility.
- Cables can be installed in tiled showers or other wet areas, although it is recommended that you check with your local electrical inspector first to verify that this application is allowed in your jurisdiction.
- Fifteen year limited warranty.

Accessories

- It is recommended that a floor temperature sensing thermostat be used to control the cable system. See *Warm Tiles™ Thermostats*.
- Relays can be used in conjunction with a thermostat to control large heated areas, where the power requirement exceeds 15 amps. See *Warm Tiles™ Floor Warming Accessories*.

Certifications

- UL Listed, CSA Certified and conform to European Directives.



Notes

- Per NEC and CEC requirements ALWAYS use a ground fault protection device (GFCI) to reduce the danger of fire from a damaged or improperly installed heating cable. Electrical fault currents caused by damaged or improperly installed cable MAY NOT BE LARGE ENOUGH to trip a conventional circuit breaker.
- Heating cables must be installed in compliance with all national, state/provincial and local codes. Check with your local electrical inspector for specific details.
- The Warm Tiles™ heating cables must be completely embedded in a cement-based layer of mortar prior to installation of the flooring material. SAM will add approximately 0.387 in (9.83 mm) to the floor height.
- Mats are not designed as a primary source of space heating for any room in which it is installed.
- Heating cable must not touch, cross or overlap itself at any point.
- Do not install heating cable under carpet, vinyl composition or linoleum type floors, or any type of nailed-down wood flooring. Floor nailing can damage the cable resulting in exposed live electrical parts and/or result in the cable overheating.
- Do not bend the heating cable at right angles – this could damage the electrical insulation; minimum bending radius is 3/4 in (19 mm).
- The heating cable of the mat must not extend beyond the room or area in which it originates.
- **DO NOT CUT THE CABLE.** Only the cold lead may be cut to suit hook-up in the electrical connection box (ECB).
- Always complete the installation resistance log and submit a copy to the owner. Take photos of the installation for record.

Warm Tiles™ SAM Mat

Floor Warming Self-Adhesive Mat. For Commercial and Residential Applications.

Measuring Walkable Area

Warm Tiles™ Self-Adhesive Mats (SAM) mesh substrate is self-adhesive allowing you to place the mat on the subfloor and have it stay put while you embed the mat in thin-set or self-leveling underlayment. Various floor areas may be warmed with a single mat or by using a combination of mats. Find each floor section's square area by multiplying the length and width of each walkable floor section. Then add each floor section's walkable square area together for the installation's total walkable square area.

Cable Kit Room Measurement Diagram

Shaded areas represent installation areas of your mat system.

A is 1 ft 8 in x 6 ft 6 in = 10.86 ft² (0.51 m x 1.98 m = 1.01 m²)

B is 1 ft 8 in x 6 ft 6 in = 10.86 ft² (0.51 m x 1.98 m = 1.01 m²)

C is 1 ft 8 in x 6 ft 6 in = 10.86 ft² (0.51 m x 1.98 m = 1.01 m²)

D is 1 ft 8 in x 2 ft 6 in = 4.18 ft² (0.51 m x 0.76 m = 0.39 m²)

A + B + C + D = ft² (m²) total walkable heated area

10.86 ft² + 10.86 ft² + 10.86 ft² + 4.18 ft² = **36.78 ft²**

(1.01 m² + 1.01 m² + 1.01 m² + 0.39 m²) = **3.42 m²** total heated area

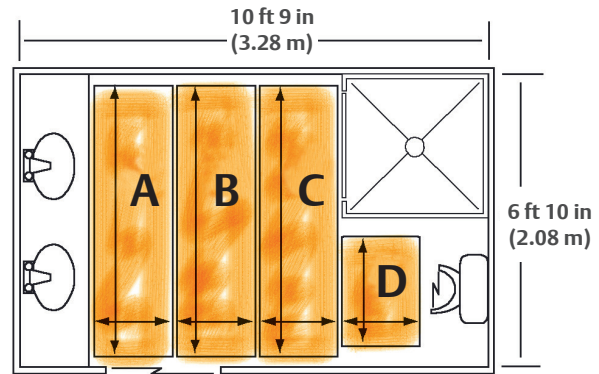

Cable Kit Room Layout Diagram

Choose the product that most closely matches your heated area square footage from the product selection chart for SAM mat kits.

In this example, you would choose 120 Vac SAM 1033 mat kit.

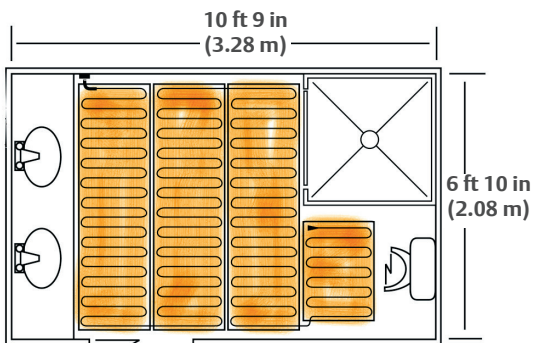

For additional layouts or help in choosing the right product for your project, contact your local sales representative.

In this example, you would choose 120 Vac SAM 1087 mat kit.

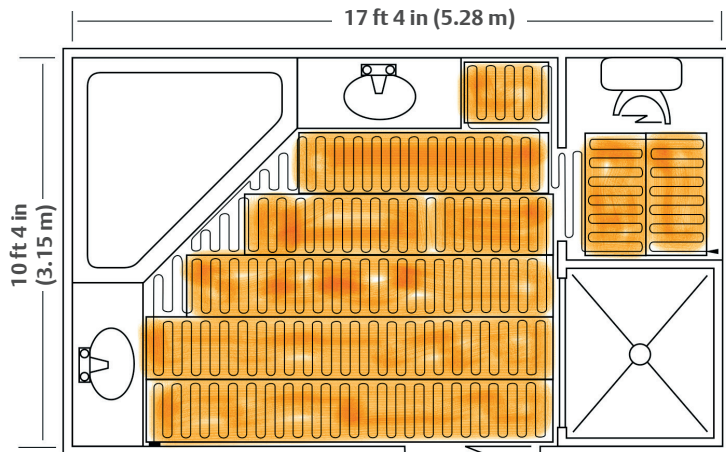

Warm Tiles™ SAM Mat

Floor Warming Self-Adhesive Mat. For Commercial and Residential Applications.

Considerations For Choosing a Mat

Choose between 120 Vac or 240 Vac, to match your power supply. For areas larger than about 70 ft² (6.50 m²), the 240 Vac kits may be more economical. All mats are 20 in (0.51 m) wide. Multiple mats may be used to increase heated area ft² (m²) of installation.

SAM 120 Vac Mat Kits

Model Number	Mat Length ft (m)	Heated Area ft ² (m ²)	Amps
SAM 1010	6.67 (2.03)	12-15 (1.11-1.39)	1.3
SAM 1013	8.67 (2.64)	16-19 (1.50-1.76)	1.7
SAM 1017	11.33 (3.45)	20-22 (1.86-2.04)	2.2
SAM 1020	13.33 (4.06)	23-28 (2.14-2.60)	2.5
SAM 1025	16.67 (5.08)	29-36 (2.69-3.34)	3.1
SAM 1033	22.00 (6.70)	37-46 (3.44-4.27)	4.2
SAM 1042	28.00 (8.53)	47-54 (4.37-5.02)	5.3
SAM 1050	33.33 (10.15)	55-66 (5.11-6.13)	6.5
SAM 1062	41.33 (12.59)	67-80 (6.22-7.43)	8.1
SAM 1075	50.00 (15.24)	81-94 (7.53-8.73)	9.7
SAM 1087	58.00 (17.68)	95-106 (8.83-9.85)	11.5 ①
SAM 1100	66.67 (20.32)	107-120 (9.94-11.15)	13.1 ①

SAM 240 Vac Mat Kits

Model Number	Mat Length ft (m)	Heated Area ft ² (m ²)	Amps
SAM 2010	6.67 (2.03)	12-15 (1.11-1.39)	0.6
SAM 2013	8.67 (2.64)	16-19 (1.50-1.76)	0.8
SAM 2017	11.33 (3.45)	20-22 (1.86-2.04)	1.1
SAM 2020	13.33 (4.06)	23-28 (2.14-2.60)	1.3
SAM 2025	16.67 (5.08)	29-36 (2.69-3.34)	1.6
SAM 2033	22.00 (6.70)	37-46 (3.44-4.27)	2.1
SAM 2042	28.00 (8.53)	47-54 (4.37-5.02)	2.8
SAM 2050	33.33 (10.15)	55-66 (5.11-6.13)	3.1
SAM 2062	41.33 (12.59)	67-80 (6.22-7.43)	4.1
SAM 2075	50.00 (15.24)	81-94 (7.53-8.73)	4.8
SAM 2087	58.00 (17.68)	95-106 (8.83-9.85)	5.7
SAM 2100	66.67 (20.32)	107-120 (9.94-11.15)	6.5

① Caution: Kit combinations that exceed 10 Amps should be connected by a qualified electrician.

Mat Shape Configurations

The heating cable of the SAM mat kit is adhered in a serpentine pattern onto lengths of mesh substrate. It is quick and easy to cover large areas. These mats can be angled, turned or completely flipped around in order to cover the space by cutting only the mesh, and moving the remaining sections of mats in a new direction. In doing this, you are creating as much walkable heated area as possible.

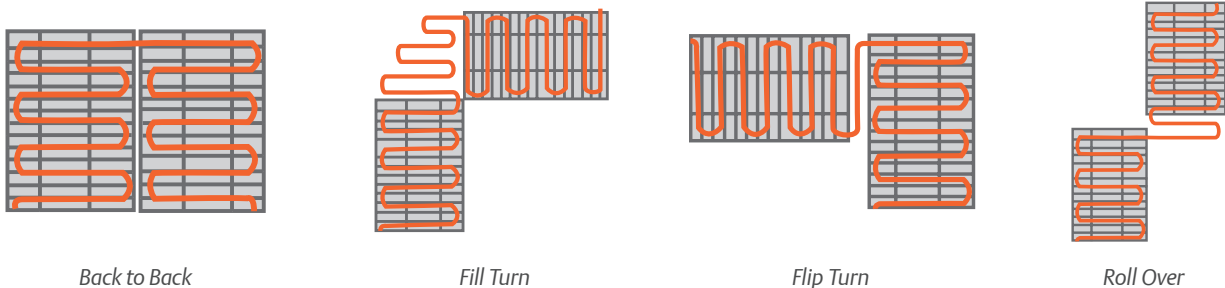

Warm Tiles™ SAM Mat

Floor Warming Self-Adhesive Mat. For Commercial and Residential Applications.

Product Selection

120 Vac					
Catalog Number	Description	Heated Area ft ² (m ²)	Carton Quantity	Carton Weight lb (kg)	UPC
SAM 1010	20 in x 6.67 ft (0.51 x 2.03 m)	12-15 (1.11-1.39)	1	3 (1.4)	01362701561
SAM 1013	20 in x 8.67 ft (0.51 x 2.64 m)	16-19 (1.50-1.76)	1	3.3 (1.5)	01362701562
SAM 1017	20 in x 11.33 ft (0.51 x 3.45 m)	20-22 (1.86-2.04)	1	3.6 (1.6)	01362701563
SAM 1020	20 in x 13.33 ft (0.51 x 4.06 m)	23-28 (2.14-2.60)	1	3.9 (1.8)	01362701564
SAM 1025	20 in x 16.67 ft (0.51 x 5.08 m)	29-36 (2.69-3.34)	1	4.3 (2.0)	01362701565
SAM 1033	20 in x 22 ft (0.51 x 6.71 m)	37-46 (3.44-4.27)	1	4.9 (2.2)	01362701566
SAM 1042	20 in x 28 ft (0.51 x 8.53 m)	47-54 (4.37-5.02)	1	5.3 (2.4)	01362701567
SAM 1050	20 in x 33.33 ft (0.51 x 10.16 m)	55-66 (5.11-6.13)	1	6.2 (2.8)	01362701568
SAM 1062	20 in x 41.33 ft (0.51 x 12.60 m)	67-80 (6.22-7.43)	1	7.5 (3.4)	01362701569
SAM 1075	20 in x 50 ft (0.51 x 15.24 m)	81-94 (7.53-8.73)	1	8.7 (3.9)	01362701570
SAM 1087	20 in x 58 ft (0.51 x 17.68 m)	95-106 (8.83-9.85)	1	9.7 (4.3)	01362701571
SAM 1100	20 in x 66.67 ft (0.51 x 20.32 m)	107-120 (9.94-11.15)	1	10.8 (4.9)	01362701572

240 Vac					
Catalog Number	Description	Heated Area ft ² (m ²)	Carton Quantity	Carton Weight lb (kg)	UPC
SAM 2010	20 in x 6.67 ft (0.51 x 2.03 m)	12-15 (1.11-1.39)	1	3 (1.4)	01362701581
SAM 2013	20 in x 8.67 ft (0.51 x 2.64 m)	16-19 (1.50-1.76)	1	3.3 (1.5)	01362701582
SAM 2017	20 in x 11.33 ft (0.51 x 3.45 m)	20-22 (1.86-2.04)	1	3.6 (1.6)	01362701583
SAM 2020	20 in x 13.33 ft (0.51 x 4.06 m)	23-28 (2.14-2.60)	1	3.9 (1.8)	01362701584
SAM 2025	20 in x 16.67 ft (0.51 x 5.08 m)	29-36 (2.69-3.34)	1	4.3 (2.0)	01362701585
SAM 2033	20 in x 22 ft (0.51 x 6.71 m)	37-46 (3.44-4.27)	1	4.9 (2.2)	01362701586
SAM 2042	20 in x 28 ft (0.51 x 8.53 m)	47-54 (4.37-5.02)	1	5.3 (2.4)	01362701587
SAM 2050	20 in x 33.33 ft (0.51 x 10.16 m)	55-66 (5.11-6.13)	1	6.2 (2.8)	01362701588
SAM 2062	20 in x 41.33 ft (0.51 x 12.60 m)	67-80 (6.22-7.43)	1	7.5 (3.4)	01362701589
SAM 2075	20 in x 50 ft (0.51 x 15.24 m)	81-94 (7.53-8.73)	1	8.7 (3.9)	01362701590
SAM 2087	20 in x 58 ft (0.51 x 17.68 m)	95-106 (8.83-9.85)	1	9.7 (4.3)	01362701591
SAM 2100	20 in x 66.67 ft (0.51 x 20.32 m)	107-120 (9.94-11.15)	1	10.8 (4.9)	01362701592

Warm Tiles™ Elite WTE Mat

Floor Warming Mats. For Residential and Commercial Applications.

Product Overview

- Warm Tiles™ Elite (WTE) mats are designed for indoor floor warming applications with minimal impact on floor height.
- Mats consist of heating cable interwoven into slim, durable fabric, and come in standard and custom, made-to-order sizes.

Applications

- WTE mats are designed to gently warm flooring materials such as:
 - Marble
 - Ceramic
 - Glass and porcelain tile
 - Slate
 - Granite
 - Poured or dimensional stone
 - Laminate and engineered hardwood products

Features

- Available in 120 and 240 Vac with standard 15 ft (4.57 m) cold leads.
- Thin 0.125 in (3.2 mm) mat means minimal impact on floor height.
- Same-day installation possible due to cost effective fabric mat design.
- High power output up to 15 W/ft², 14 W/ft² for select models, provides ample heat to quickly and efficiently warm up floors.
- Custom mats are available for various shaped areas. Contact your local sales representative for details.
- Cables can be installed in tiled showers or other wet areas, although it is recommended that you check with your local electrical inspector first to verify that this application is allowed in your jurisdiction.
- Fifteen year limited warranty.

Ordering Information

- We can assist you to determine the appropriate WTE mat for your application. Contact your local sales representative for details.

Accessories

- It is recommended that a floor temperature sensing thermostat be used to control the cable system. See *Warm Tiles™ Thermostats*.
- Relays can be used in conjunction with a thermostat to control large heated areas, where the power requirement exceeds 15 amps. See *Warm Tiles™ Floor Warming Accessories*.

Certifications

- UL Listed and CSA Certified.



Notes

- Per NEC and CEC requirements ALWAYS use a ground fault protection device (GFCI) to reduce the danger of fire from a damaged or improperly installed heating cable. Electrical fault currents caused by damaged or improperly installed cable MAY NOT BE LARGE ENOUGH to trip a conventional circuit breaker.
- Heating cables must be installed in compliance with all national, state/provincial and local codes. Check with your local electrical inspector for specific details.
- The Warm Tiles™ heating cables must be completely embedded in a cement-based layer of mortar prior to installation of the flooring material. WTE will add approximately 0.211 in (5.36 mm) to the floor height.
- Do not install heating cable under carpet, vinyl composition or linoleum type floors, or any type of nailed-down wood flooring. Floor nailing can damage the cable resulting in exposed live electrical parts and/or result in the cable overheating.
- Cables are not designed as a primary source of space heating for any room in which it is installed.
- Do not alter the length of the heating cable (inside the heating mat) to suit a floor area larger or smaller than the recommended range for that mat: the cable will overheat or not warm properly. Physical injury or fire may result if altered. Only the cold lead may be cut to suit the location of the electrical connection box.
- When using multiple WTE mats, ensure the outside wire of adjacent mats are within 1-1/2 in (38 mm) to 3 in (76 mm) of one another to ensure the cable spacing and heat distribution are consistent across the floor.
- Spacing closer than 1-1/2 in (38 mm), can cause the cable to overheat. Do not space mats greater than 3 in (76 mm) apart, as the floor will not warm to a comfortable temperature.

Warm Tiles™ Elite WTE Mat

Floor Warming Mats. For Residential and Commercial Applications.

Walkable Area

Warm Tiles™ Elite (WTE) mats allow you to install full floor warming coverage with the least impact on floor level. Various floor areas may be warmed with a single mat or by using a combination of mats.

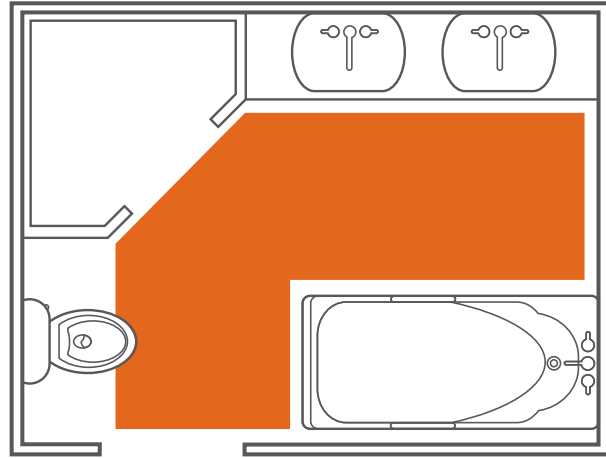
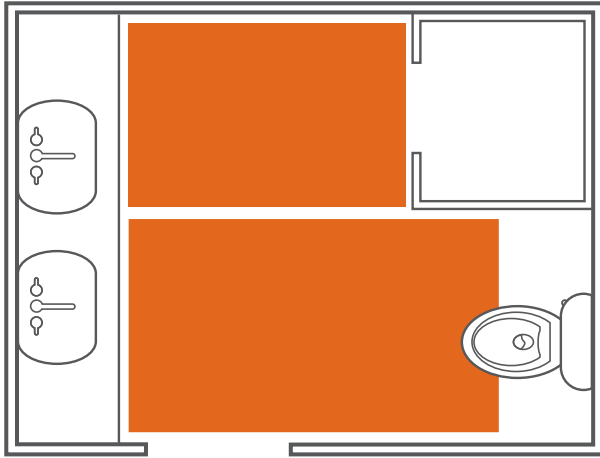

Standard Configuration

Flexible and easy to install. Available in popular sizes for rectangular areas.

Custom Configuration

Available for coverage in rooms with irregular shapes and obstacles.

Standard Product Selection for 120 Vac

Catalog Number	Length in (m)	Width in (m)	Heated Area ft ² (m ²)	Carton Quantity	Carton Weight lb (kg)	UPC
WTE0400271	40 (1.02)	27 (0.69)	7.5 (0.70)	1	2.9 (1.3)	01362716538
WTE0400321	40 (1.02)	32 (0.81)	8.9 (0.83)	1	3.0 (1.4)	01362716546
WTE0400401	40 (1.02)	40 (1.02)	11.1 (1.03)	1	3.1 (1.4)	01362716442
WTE0400481	40 (1.02)	48 (1.22)	13.3 (1.24)	1	3.2 (1.5)	01362716537
WTE0480241	48 (1.22)	24 (0.61)	8.0 (0.74)	1	2.9 (1.3)	01362716443
WTE0480301	48 (1.22)	30 (0.76)	10.0 (0.93)	1	3.0 (1.4)	01362716501
WTE0480361	48 (1.22)	36 (0.91)	12.0 (1.11)	1	3.2 (1.5)	01362716541
WTE0480481	48 (1.22)	48 (1.22)	16.0 (1.49)	1	3.4 (1.5)	01362716444
WTE0600241	60 (1.52)	24 (0.61)	10.0 (0.93)	1	4.0 (1.8)	01362716446
WTE0600301	60 (1.52)	30 (0.76)	12.5 (1.16)	1	4.2 (1.9)	01362716542
WTE0600361	60 (1.52)	36 (0.91)	15.0 (1.39)	1	4.4 (2.0)	01362716543
WTE0600421	60 (1.52)	42 (1.67)	17.5 (1.63)	1	4.5 (2.0)	01362716447
WTE0600481	60 (1.52)	48 (1.22)	20.0 (1.86)	1	4.7 (2.1)	01362716544
WTE0600601	60 (1.52)	60 (1.52)	25.0 (2.32)	1	5.0 (2.3)	01362716450
WTE0720241	72 (1.83)	24 (0.61)	12.0 (1.11)	1	4.2 (1.9)	01362716458
WTE0720301	72 (1.83)	30 (0.76)	15.0 (1.39)	1	4.4 (2.0)	01362716460
WTE0720361	72 (1.83)	36 (0.91)	18.0 (1.67)	1	4.6 (2.1)	01362716545

Warm Tiles™ Elite WTE Mat

Floor Warming Mats. For Residential and Commercial Applications.

Standard Product Selection for 120 Vac

Catalog Number	Length in (m)	Width in (m)	Heated Area ft ² (m ²)	Carton Quantity	Carton Weight lb (kg)	UPC
WTE0720421	72 (1.83)	42 (1.67)	21.0 (1.95)	1	4.8 (2.2)	01362716463
WTE0720481	72 (1.83)	48 (1.22)	24.0 (2.23)	1	5.0 (2.3)	01362716539
WTE0720601	72 (1.83)	60 (1.52)	30.0 (2.79)	1	5.4 (2.4)	01362716464
WTE0840241	84 (2.13)	24 (0.61)	14.0 (1.30)	1	4.3 (2.0)	01362716468
WTE0840301	84 (2.13)	30 (0.76)	17.5 (1.63)	1	4.5 (2.0)	01362716469
WTE0840361	84 (2.13)	36 (0.91)	21.0 (1.95)	1	4.8 (2.2)	01362716470
WTE0840421	84 (2.13)	42 (1.67)	24.5 (2.28)	1	5.0 (2.3)	01362716472
WTE0840481	84 (2.13)	48 (1.22)	28.0 (2.60)	1	5.2 (2.4)	01362716473
WTE0840601	84 (2.13)	60 (1.52)	35.0 (3.25)	1	5.7 (2.6)	01362716475
WTE0960241	96 (2.44)	24 (0.61)	16.0 (1.49)	1	4.4 (2.0)	01362716476
WTE0960301	96 (2.44)	30 (0.76)	20.0 (1.86)	1	4.7 (2.1)	01362716440
WTE0960361	96 (2.44)	36 (0.91)	24.0 (2.23)	1	5.0 (2.3)	01362716480
WTE0960421	96 (2.44)	42 (1.67)	28.0 (2.60)	1	5.2 (2.4)	01362716479
WTE0960481	96 (2.44)	48 (1.22)	32.0 (2.97)	1	5.5 (2.5)	01362716478
WTE0960601	96 (2.44)	60 (1.52)	40.0 (3.72)	1	6.0 (2.7)	01362716477
WTE1080241	108 (2.74)	24 (0.61)	18.0 (1.67)	1	4.6 (2.1)	01362716474
WTE1080301	108 (2.74)	30 (0.76)	22.5 (2.09)	1	4.9 (2.2)	01362716471
WTE1080361	108 (2.74)	36 (0.91)	27.0 (2.51)	1	5.2 (2.4)	01362716467
WTE1080421	108 (2.74)	42 (1.67)	31.5 (2.93)	1	5.5 (2.5)	01362716466
WTE1080481	108 (2.74)	48 (1.22)	36.0 (3.34)	1	5.8 (2.6)	01362716465
WTE1080601	108 (2.74)	60 (1.52)	45.0 (4.18)	1	6.4 (2.9)	01362716461
WTE1180241	118 (3.00)	24 (0.61)	19.7 (1.83)	1	4.7 (2.1)	01362716451
WTE1180301	118 (3.00)	30 (0.76)	24.6 (2.29)	1	5.0 (2.3)	01362716449
WTE1180361	118 (3.00)	36 (0.91)	29.5 (2.74)	1	5.3 (2.4)	01362716448
WTE1180421	118 (3.00)	42 (1.67)	34.4 (3.20)	1	5.7 (2.6)	01362716445
WTE1180481	118 (3.00)	48 (1.22)	39.3 (3.65)	1	6.0 (2.7)	01362716481
WTE1180601	118 (3.00)	60 (1.52)	49.2 (4.57)	1	6.6 (3.0)	01362716441

Warm Tiles™ Elite WTE Mat

Floor Warming Mats. For Residential and Commercial Applications.

Standard Product Selection for 240 Vac

Catalog Number	Length m (in)	Width m (in)	Heated Area m ² (ft ²)	Carton Quantity	Carton Weight kg (lb)	UPC
WTE0400272	40 (1.02)	27 (0.69)	7.5 (0.70)	1	2.9 (1.3)	01362716513
WTE0400322	40 (1.02)	32 (0.81)	8.9 (0.83)	1	3.0 (1.4)	01362716512
WTE0400402	40 (1.02)	40 (1.02)	11.1 (1.03)	1	3.1 (1.4)	01362716462
WTE0400482	40 (1.02)	48 (1.22)	13.3 (1.24)	1	3.2 (1.5)	01362716507
WTE0480242	48 (1.22)	24 (0.61)	8.0 (0.74)	1	2.9 (1.3)	01362716510
WTE0480302	48 (1.22)	30 (0.76)	10.0 (0.93)	1	3.0 (1.4)	01362716498
WTE0480362	48 (1.22)	36 (0.91)	12.0 (1.11)	1	3.2 (1.5)	01362716499
WTE0480482	48 (1.22)	48 (1.22)	16.0 (1.49)	1	3.4 (1.5)	01362716500
WTE0600242	60 (1.52)	24 (0.61)	10.0 (0.93)	1	4.0 (1.8)	01362716482
WTE0600302	60 (1.52)	30 (0.76)	12.5 (1.16)	1	4.2 (1.9)	01362716483
WTE0600362	60 (1.52)	36 (0.91)	15.0 (1.39)	1	4.4 (2.0)	01362716484
WTE0600422	60 (1.52)	42 (1.67)	17.5 (1.63)	1	4.5 (2.0)	01362716503
WTE0600482	60 (1.52)	48 (1.22)	20.0 (1.86)	1	4.7 (2.1)	01362716504
WTE0600602	60 (1.52)	60 (1.52)	25.0 (2.32)	1	5.0 (2.3)	01362716505
WTE0720242	72 (1.83)	24 (0.61)	12.0 (1.11)	1	4.2 (1.9)	01362716506
WTE0720302	72 (1.83)	30 (0.76)	15.0 (1.39)	1	4.4 (2.0)	01362716508
WTE0720362	72 (1.83)	36 (0.91)	18.0 (1.67)	1	4.6 (2.1)	01362716509
WTE0720422	72 (1.83)	42 (1.67)	21.0 (1.95)	1	4.8 (2.2)	01362716511
WTE0720482	72 (1.83)	48 (1.22)	24.0 (2.23)	1	5.0 (2.3)	01362716516
WTE0720602	72 (1.83)	60 (1.52)	30.0 (2.79)	1	5.4 (2.4)	01362716517
WTE0840242	84 (2.13)	24 (0.61)	14.0 (1.30)	1	4.3 (2.0)	01362716518
WTE0840302	84 (2.13)	30 (0.76)	17.5 (1.63)	1	4.5 (2.0)	01362716519
WTE0840362	84 (2.13)	36 (0.91)	21.0 (1.95)	1	4.8 (2.2)	01362716524
WTE0840422	84 (2.13)	42 (1.67)	24.5 (2.28)	1	5.0 (2.3)	01362716526
WTE0840482	84 (2.13)	48 (1.22)	28.0 (2.60)	1	5.2 (2.4)	01362716528
WTE0840602	84 (2.13)	60 (1.52)	35.0 (3.25)	1	5.7 (2.6)	01362716529
WTE0960242	96 (2.44)	24 (0.61)	16.0 (1.49)	1	4.4 (2.0)	01362716531
WTE0960302	96 (2.44)	30 (0.76)	20.0 (1.86)	1	4.7 (2.1)	01362716532
WTE0960362	96 (2.44)	36 (0.91)	24.0 (2.23)	1	5.0 (2.3)	01362716534
WTE0960422	96 (2.44)	42 (1.67)	28.0 (2.60)	1	5.2 (2.4)	01362716535
WTE0960482	96 (2.44)	48 (1.22)	32.0 (2.97)	1	5.5 (2.5)	01362716536
WTE0960602	96 (2.44)	60 (1.52)	40.0 (3.72)	1	6.0 (2.7)	01362716540
WTE1080242	108 (2.74)	24 (0.61)	18.0 (1.67)	1	4.6 (2.1)	01362716502
WTE1080302	108 (2.74)	30 (0.76)	22.5 (2.09)	1	4.9 (2.2)	01362716492
WTE1080362	108 (2.74)	36 (0.91)	27.0 (2.51)	1	5.2 (2.4)	01362716533
WTE1080422	108 (2.74)	42 (1.67)	31.5 (2.93)	1	5.5 (2.5)	01362716530
WTE1080482	108 (2.74)	48 (1.22)	36.0 (3.34)	1	5.8 (2.6)	01362716527
WTE1080602	108 (2.74)	60 (1.52)	45.0 (4.18)	1	6.4 (2.9)	01362716525
WTE1180242	118 (3.00)	24 (0.61)	19.7 (1.83)	1	4.7 (2.1)	01362716523
WTE1180302	118 (3.00)	30 (0.76)	24.6 (2.29)	1	5.0 (2.3)	01362716522
WTE1180362	118 (3.00)	36 (0.91)	29.5 (2.74)	1	5.3 (2.4)	01362716521
WTE1180422	118 (3.00)	42 (1.67)	34.4 (3.20)	1	5.7 (2.6)	01362716520
WTE1180482	118 (3.00)	48 (1.22)	39.3 (3.65)	1	6.0 (2.7)	01362716515
WTE1180602	118 (3.00)	60 (1.52)	49.2 (4.57)	1	3.0 (6.6)	01362716514

Warm Tiles™ Elite WTE Mat

Floor Warming Mats. For Residential and Commercial Applications.

Custom Floor Warming-Mats (WTE)

If the layout or installation conditions prevent the use of the standard Warm Tiles™ Elite product offering, our team will work with you to create custom WTE mats tailored to your unique specifications and layout. Submit the WTE Custom Order Form with all the required information, and the Warm Tiles™ Application Engineering team will design a custom mat just for you.

Catalog Number Guide

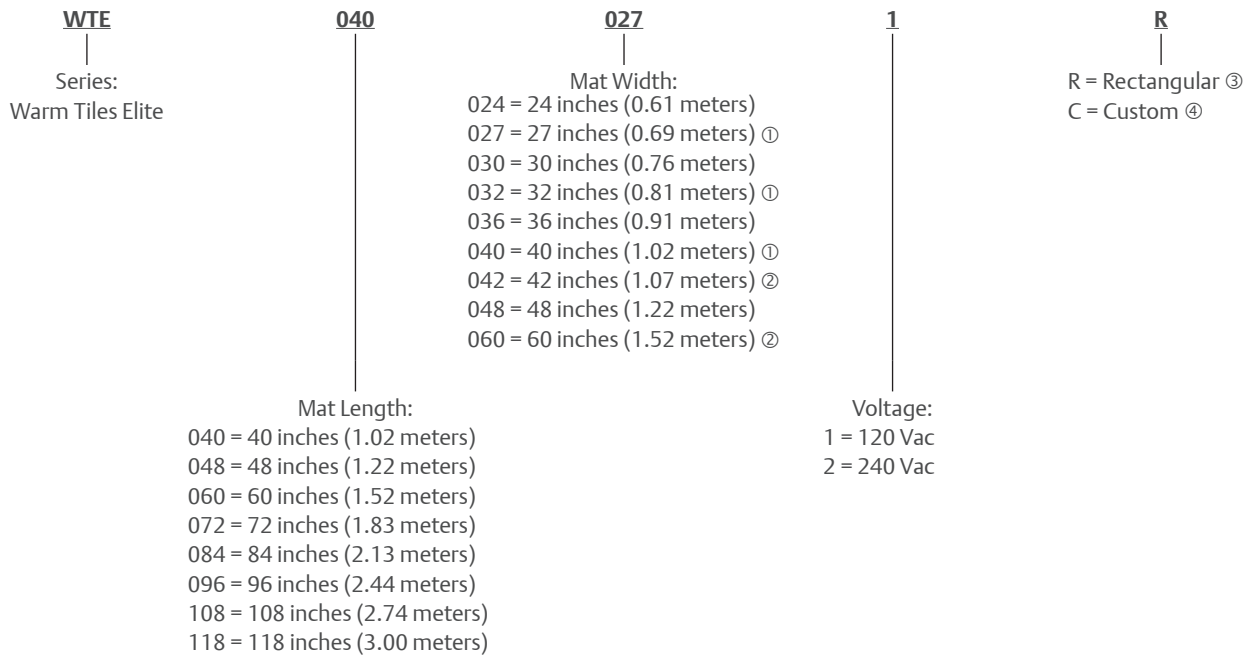

- ① Only available for mat length of 40 in (1.02 m).
- ② Not available for mat lengths of 40 in and 48 in (1.02 and 1.22 m).
- ③ Custom rectangular shape mat without any notches or cutouts will have a suffix "R" after its main part number. Example: WTE0630491R – 63 in x 49 in (1.60 m x 1.24 m), 120 Vac special size RECTANGULAR custom WTE mat.
- ④ Irregular shape custom mat that may contain any combination of notches, cutouts, bevels, etc. Example: WTE0630491C023 – 63 inches x 49 inches (1.60 m x 1.24 m), 120 Vac special size irregular shape CUSTOM mat with a unique design (three-digit code behind "C" suffix is assigned by application engineering team).

Custom Mat Shapes

WTE mats can be provided in custom sizes or shapes – some typical shapes may include:

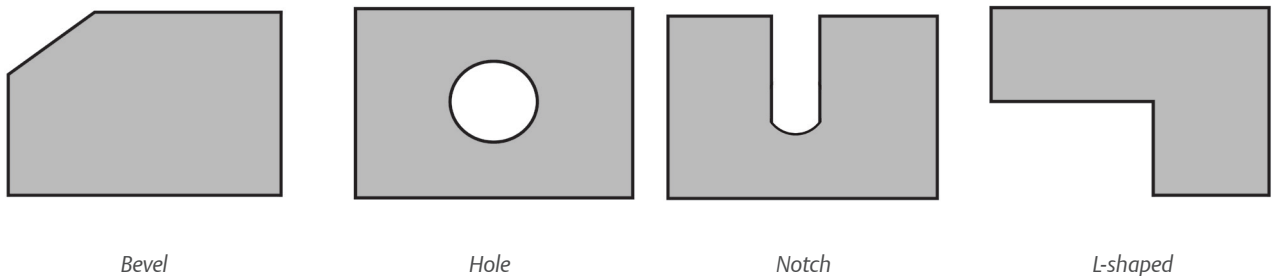

Note: Contact a local sales representative for assistance.

Warm Tiles™ FG and FGS Thermostats

Floor Warming. For Residential and Commercial Applications.

Product Overview

- Warm Tiles™ floor warming thermostats are designed to offer precise temperature control for all Warm Tiles™ floor warming systems.

Applications

- Monitors and regulates the warmth of Warm Tiles™ heated floors.

Features

- FGS programmable thermostat cycles on and off automatically to suit 5/2 or full 7 day schedules.
- FG non-programmable thermostat for manual operation with a simple temperature adjustment and on/off switch.
- Thermostats have dual 120/240 Vac design and control loads up to 15 Amps total system current.
- Integrated GFCI meets NEC/CEC electrical code with no need to buy and install a separate GFCI on systems under 15 amps.
- Responsive buttons and intuitive feedback simplify operation.
- Large, easy to read, backlit LCD display.
- Eighteen month limited warranty.

Certifications

- CSA Certified to US and Canadian Standards.

Notes

- Thermostats are designed for indoor use only and should not be installed in areas where it can be exposed to water or rain.



FG Thermostat



FGS Thermostat

Product Selection

Catalog Number	Description	Carton Quantity	Carton Weight lb (kg)	UPC
FG	120/240 Vac dual-voltage 15A non-programmable thermostat	5	8 (3.6)	01362716585
FGS	120/240 Vac dual-voltage 15A programmable thermostat	5	8 (3.6)	01362716584

Warm Tiles™ ES and ESW WiFi ColorTouch Thermostats

Floor Warming. For Residential and Commercial Applications.

Product Overview

- The Warm Tiles ES ColorTouch floor warming thermostat is designed to offer precise temperature control for all Warm Tiles floor warming systems.
- The Warm Tiles ESW WiFi ColorTouch Thermostat allows monitoring and precise control of Warm Tiles floor warming systems remotely from a web browser, Android or iOS smartphone or tablet. It offers all the same features of the ES Thermostat with the addition of wifi capability for remote access.

Applications

- Monitors and regulates the warmth of Warm Tiles heated floors.
- ESW allows for remote monitoring and controlling of the Warm Tiles floor warming systems, via a user-friendly app or laptop pc.

Features

- Standard Thermostat:
 - 3.5" color screen with easy interactive touch control.
 - Programmable thermostat allowing for 6 programming periods per day.
 - Integral relay switch can control up to 15 amps at either 115 Vac or 230 Vac.
 - Includes 5 mA built-in ground fault circuit interrupter (GFCI) with indicator light.
 - Track thermostat power consumption in the energy log.
 - Lockout feature prevents others from tampering with thermostat settings.
 - 5-year battery back-up included.
 - 3 year plus 3 month warranty.
- ES Thermostat:
 - Three control modes: Floor, Ambient, Floor/Ambient
- ESW WiFi Thermostat:
 - WLAN connectivity for remote access.
 - Connects to standard home wifi, no hub required.
 - Monitor and precisely control any Warm Tiles floor warming system from a web browser, Android™ or iOS™ smartphone or tablet.
 - Compatible with iPhone™ and iPad™ devices using iOS™ operating system.
 - Compatible Samsung™ and Motorola™ devices using Android™ operating systems.
 - Local weather information can be displayed on the thermostat with just a tap of the screen.
 - Black back-lit screen with white characters proves high contrast for easy readability from a distance and in bright or dark environments.

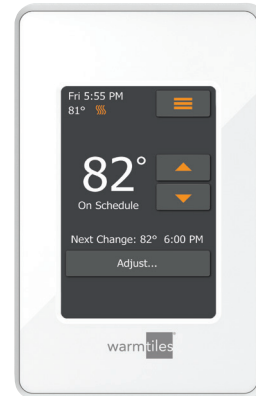

ES Thermostat

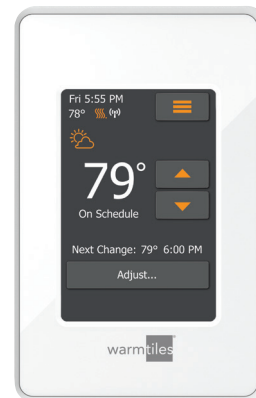

ESW Thermostat



Certifications

- UL Listed for use in the United States and Canada.

Notes

- Thermostats are designed for indoor use only and should not be installed in areas where it can be exposed to water or rain.

Product Selection

Catalog Number	Description	Dimensions in (mm)	Carton Quantity	Carton Weight lb (kg)	UPC
ES	Color Touch-Screen Thermostat, 115/230 Vac, 15A	3.5x6 (89x152)	1	1 (0.4)	013627002395
ESW	WiFi-enabled Color Touch-Screen Thermostat 120/240V, 15A	3.5x6 (89x152)	1	1 (0.3)	013627002982

Warm Tiles™ Floor Warming Accessories

Floor Warming. For Residential and Commercial Applications.

Product Overview

- Warm Tiles™ provides the right accessories to install our floor warming systems.

Detecto DT1 Heating Cable and Mat Fault Indicator

- The Detecto DT1 heating cable and mat fault indicator (battery operated) is designed to monitor Warm Tiles™ cable or mat systems at every step during installation.
- Detecto DT1 sounds an alarm immediately in the event of a ground fault detection, or an open or shorted connection in the cable.
- One year limited warranty.



Detecto DT1 Heating Cable and Mat Fault Indicator

Relay Kits

- The Warm Tiles™ relay kits (RK1 and RK2) allows you to connect multiple floor warming kits to a single thermostat, when power required exceeds 15 amps.
- One year limited warranty.



RK1 and RK2 Relay Kits

DFTRK Repair Kit

- The DFTRK repair kit can be used to make repairs to damaged floor heating cables and is suitable for use on most types of heating cables/mats with either single or dual conductor heating elements.
- One year limited warranty.



DFTRK Warm Tiles™ Repair Kit

Other Accessories

- Warm Tiles™ offers other accessories including replacement clips, strapping and concrete tape for your floor warming needs.
- One year limited warranty.

Certifications

- Detecto DT1 conforms to European Directives.
- Relay kits (RK1 and RK2) are UL Listed to US and Canadian Safety Standards.



CKT

Product Selection

Catalog Number	Description	Carton Quantity	Carton Weight lb (kg)	UPC
RK1	Relay kit, 120 Vac, 24 Amps	1	0.5 (0.2)	01362701298
RK2	Relay kit, 240 Vac, 24 Amps	1	0.5 (0.2)	01362701299
DFTRK	Warm Tiles™ repair kit	1	0.5 (0.2)	01362701271
DFTCK	Metal strapping kit (1) 25 ft (7.62 m) reel	1	1.5 (0.7)	01362701638
CKT	Concrete kit tape, 25 ft (7.62 m)	1	0.5 (0.2)	01362701297
10685001	Clips (50 per bag)	1	0.2 (0.1)	01362700283
10739001	Replacement temperature sensor	1	0.3 (0.1)	01362700163
DT1	Detecto electric fault indicator	1	1.0 (0.5)	01362701296
DFTS	EasyStrap Plastic Strapping Strips for DFT cables, 10 Pack	1	0.5 (1.0)	013627001370
DMCS	EasyStrap Plastic Strapping Strips for DMC cables, 25 Pack	1	1.1 (2.4)	013627003804

Warm Tiles™ Floor Warming Accessories

Relay Kits for Electric Floor Warming Systems. For Commercial and Residential Applications.

Guidelines for Floor Warming Relay Kits

Warm Tiles™ relay kits allow you to connect two or more floor warming kits in the same room. First you would connect the first line voltage feed to the thermostat. The load connection pigtails from the thermostat are run to the coil of the relay, which is housed in a separate electrical box. A second line voltage feed is connected to the input terminals of the relay and the heating cable cold leads are connected to the output terminals. When the thermostat calls for heat, the coil is engaged, connecting the input and output terminals, therefore allowing power to flow to the cables. Remember to follow the detailed instructions provided in each relay kit.

NOTE: It is recommended that the circuit supplying the heating cable have ground fault protection; this is mandatory by electrical code for some applications in many regions. Consult an electrical inspector to determine the specific ground fault requirements for your application prior to installation. If you are unsure that your circuit has ground fault protection, consult an electrician. Per US National Electrical Code - Installation in a bathroom requires that this product be installed on a circuit protected by a separate Ground Fault Circuit Interrupter (GFCI).

Basic Guidelines for 120 Vac floor warming kit combinations up to 24 Amps and require the use of a relay.

RK-1 120 Vac Thermostat Relay Kit

- Provides large area coverage using only 1 thermostat
- Switches 2 separate multiple 120 Vac floor warming systems, each with a total 24 Amp maximum load.

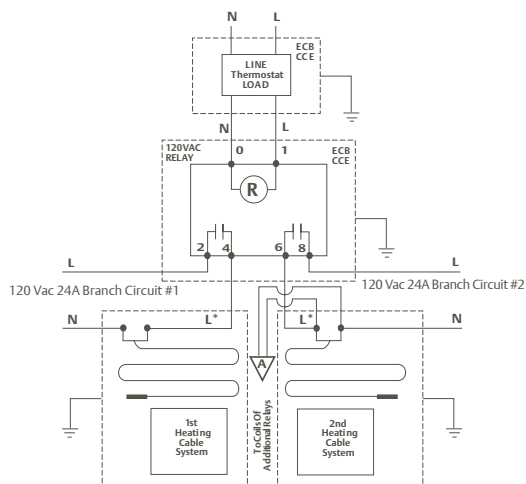

Basic Guidelines for 240 Vac floor warming kit combinations up to 24 Amps and require the use of a relay.

RK-2 240 Vac Thermostat Relay Kit

- Provides large area coverage using only 1 thermostat
- Switches multiple 240 Vac floor warming systems with a total 24 Amp maximum load.

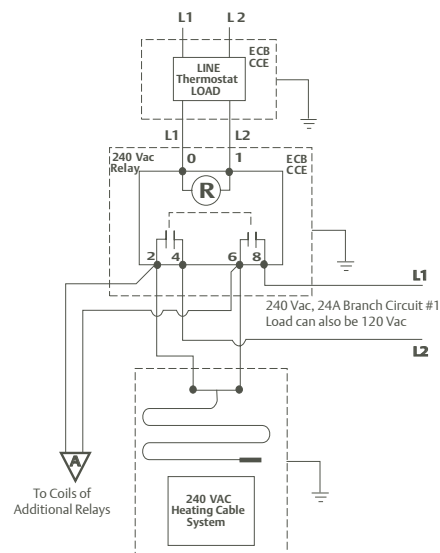

Floor Warming Terminology Guide

Warm Tiles™ radiates warmth through a network of low profile warming cables, mats, hardware and electrical controls for an economical and long lasting floor warming system. The following terms may appear frequently throughout your installation. Each is graphically illustrated in this key illustration.

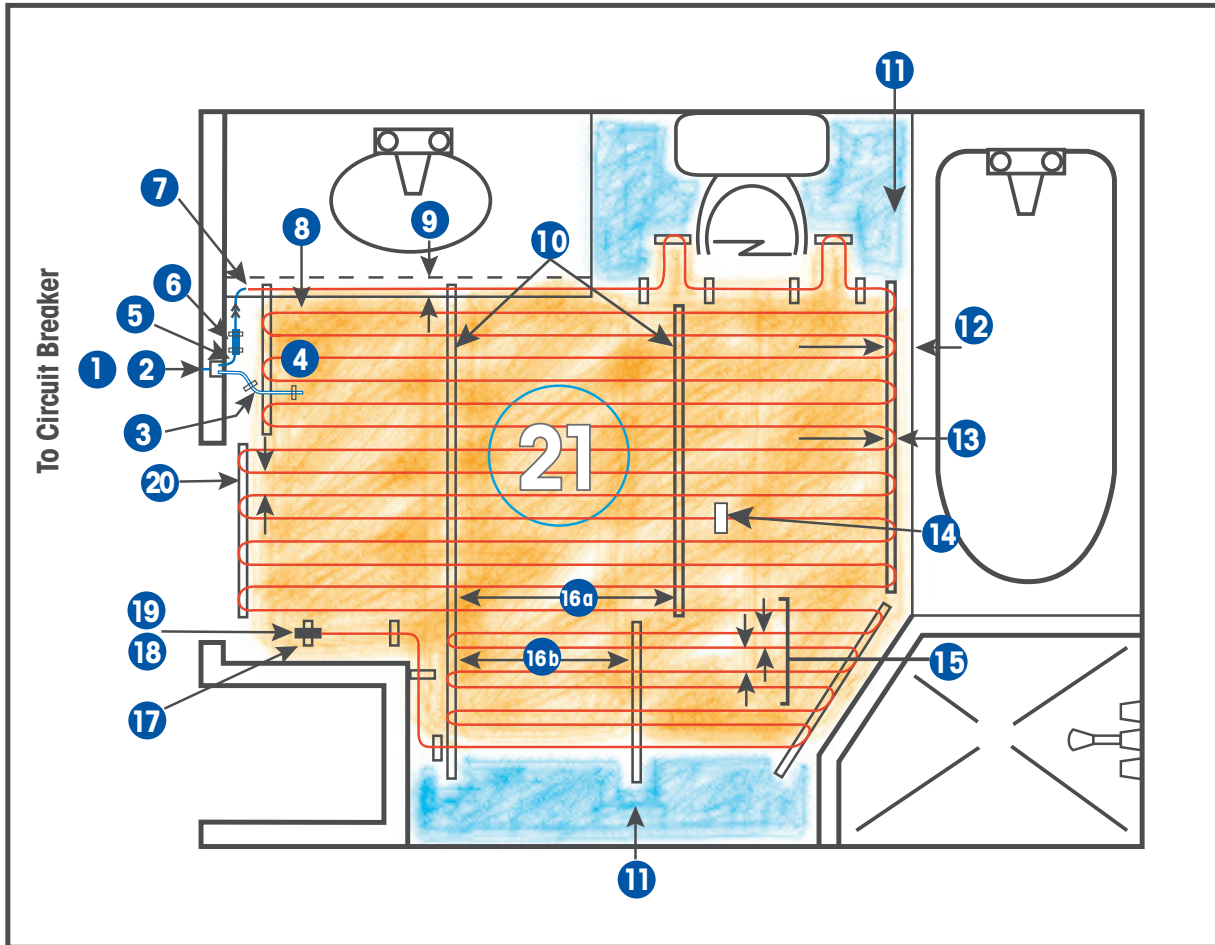

Floor Warming Terminology Guide

1. Power Supply

Wiring The 120 Vac or 240 Vac customer-supplied power cable; terminated in the circuit breaker panel and pulled into the ECB for connection to the heating controller.

2. Electrical Connection Box (ECB)

Customer-supplied electrical enclosure that houses the heating controller for the heating cable system. Cold lead is pulled through the wall cavity and into the ECB using the fish cords.

3. Sensor Wire

If a floor temperature-sensing heating controller will be used, it is necessary to install a sensor wire at the same time as the cable system. The sensor wire relays changes in floor temperature to the heating controller, which maintains the floor temperature at the desired level.

4. Dimension 6" (15.24 mm)

Minimum distance the sensor wire should extend between two adjacent runs of heating cable, measured from the arc of the return loop.

5. Cold Lead

Non-heated section of cable that transports current to the heating cable section; has a black outer jacket, covering a copper braid and two inner color-coded conductors (black/white for 120 Vac cables or red/black for 240 Vac cables), and is slightly larger in diameter than the heating cable section.

6. Cold Lead Splice

Factory connection between the cold lead and heating cable; can be recessed 0.25" (25 mm) into the sub-floor, due to its slightly larger diameter.

7. Start-of-Run

Location of the cold lead splice; where the heated section of cable begins.

8. Heating Cable

Section of cable that warms the floor; has clear outer covering with visible underlying copper braid.

9. Dimension 1.5" (3.80 mm)

Minimum distance permitted between sections of heating cable or between heating cable and walls, vanity kick plates and fixtures.

10. Cable Strapping

12" strips of plastic strapping used to harness the heating cable to the floor; may be cut to length as needed.

11. Low Traffic Areas

Sections of the floor that are seldom walked upon and do not require heating cable coverage unless it is necessary to use up surplus cable.

12. Border Dimension

Space between the outside perimeter of the heating cable and the surrounding room walls; may be set to 1.5" – 6" (3.80 cm – 15.24 cm) as required, to slightly alter the heated area and enable a proper fit with the selected DFT Cable.

13. Return Loop

Location where the heating cable turns 180° through the cable strapping, forming a loop that extends .75" (19 mm) [1" (25 mm) max.] beyond the strapping cable slots.

14. "Half of Cable" Marker

Label attached to the heating cable at its mid-point, which should appear during installation at the "Half of Heated Area" line drawn on the floor (Step 3). Serves as a useful mid-installation check as to whether or not there will be a cable surplus or shortage at the end-of-run for cables over 27 ft (8.23 m) a one quarter and three quarter marker are also used.

15. Alternating Heating Cable Spacing

The heating cable configuration used for floors above unheated areas and concrete slabs. Cable is laced through the strapping at repeating spacing intervals of 1.5" – 3" – 1.5" – 3" (3.80 cm – 7.6 cm – 3.80 cm – 7.6 cm), etc. using the pre-dimensioned holes of the cable strapping (also see *Standard Heating Cable Spacing*).

16. Cable Strapping Spacing

Distance between parallel rows of the cables trapping. To prevent contact between adjacent runs of heating cable, a minimum separation must be maintained. For Standard Heating Cable Spacing (see 16a in the key) the maximum separation is 36" (91.44 cm). For Alternating Heating Cable Spacing (see 16b in the Key) the maximum separation is 24" (60.96 cm).

17. Ribbon Strapping

Plastic strips, 1" (25 mm) wide and 12" (30.48 cm) long; may be cut to length and stapled, to fasten to the cold lead splice and tail splice to the floor.

18. Tail Splice

Factory connection between the heating cable conductors located at the end-of-run (uncoiled from the spool last).

19. End-of-Run

Location where the Tail Splice is secured to the sub-floor (Step 8). With Warm Tiles™ DFT Cable there is no need to route the end-of-run back to the ECB.

20. Standard Heating Cable Spacing

The Heating Cable configuration normally used on wood sub-floors located above heated areas. Cable is laced through the cable strapping at a constant spacing interval of 3" (7.61 cm) between adjacent cable runs (also see *Alternating Heating Cable Spacing*).

21. Heated Area

Area physically covered by the heating cable; typically much smaller than the total room area since it does not include vanities, fixtures and low traffic areas.

Floor warming systems available in a wide variety of sizes and configurations.



Your local contact: warmtiles.com

**United States
(Headquarters)**
Appleton Grp LLC
9377 W. Higgins Road
Rosemont, IL 60018
United States
T +1 800 621 1506

Canada
EGS Electrical Group Canada Ltd.
99 Union Street
Elmira ON, N3B 3L7
Canada
T +1 888 765 2226

 warmtiles.com

 [LinkedIn.com/emerson](https://www.linkedin.com/company/emerson)

Warm Tiles™ and Emerson are trade names and trademarks that are registered in the U.S. Patent and Trademark Office. Warm Tiles™ heating cable systems are produced by EasyHeat Inc. EasyHeat, Inc. is a wholly owned subsidiary of Appleton Grp LLC, a business of Emerson Electric Co. All other product or service names are the property of their registered owners. © 2021



CONSIDER IT SOLVED™